

# DRIVE LEVERS:



□ XDL-100



□ XDL-110



□ XDL-120



□ XDL-130



□ XDL-140



□ XDL-150



□ XVL-800



□ XVL-805

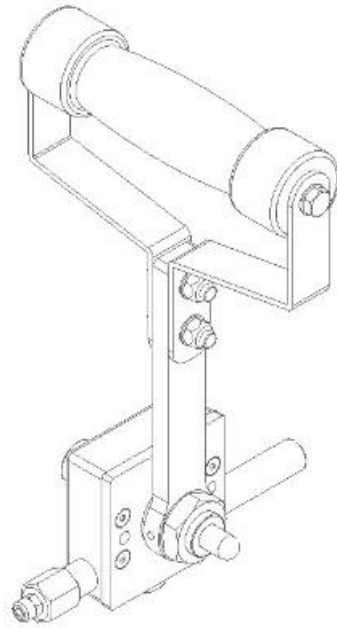

- ❑ Light Duty Rack & Pinion Control with Detent.
- ❑ Standard Travel 50mm.
- ❑ Aluminum Housing & Steel Gear Set.
- ❑ Suitable For Hydraulic Motor Control

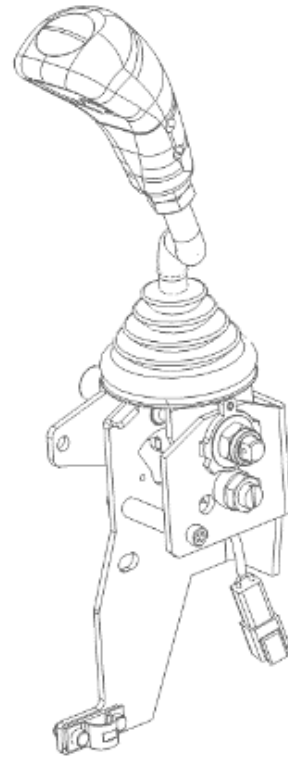

- FNR Lever
- Max. Travel: 44 mm.
- Bracket & Arm in Pressed Steel.
- Equipped With Vibration Cut Off Switch.

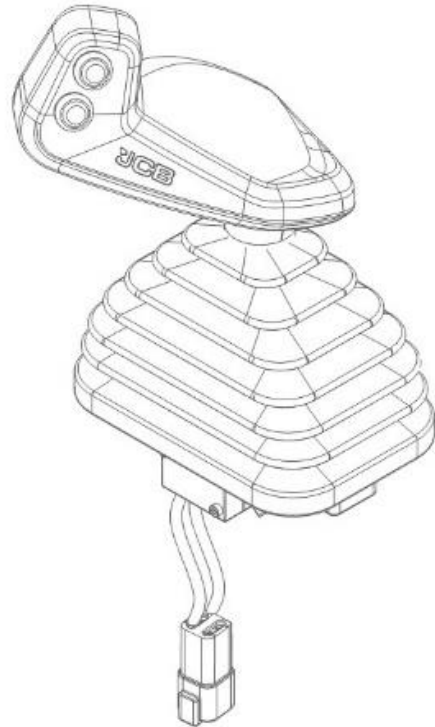

- FNR Lever.
- Max. Travel: 60 mm.
- Bracket in Al Alloy & Arm in Steel.
- Equipped With Neutral, Reverse, Horn & Vibration Cut Off Switch.

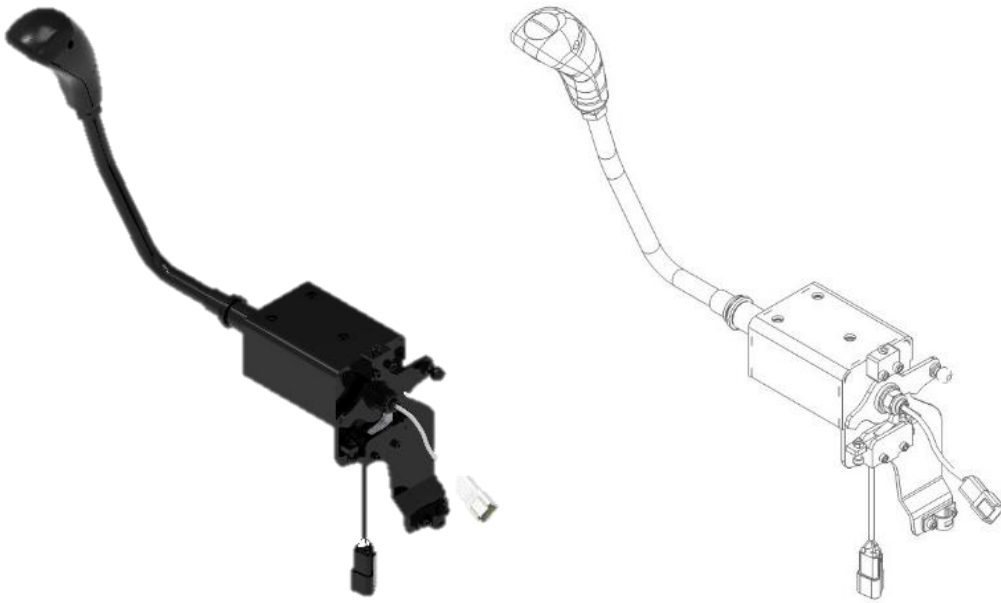

- FNR Lever**
- Max. Travel: 60 mm.**
- Bracket & Arm in Pressed Steel.**
- Equipped With Reverse & Vibration Cut Off Switch.**

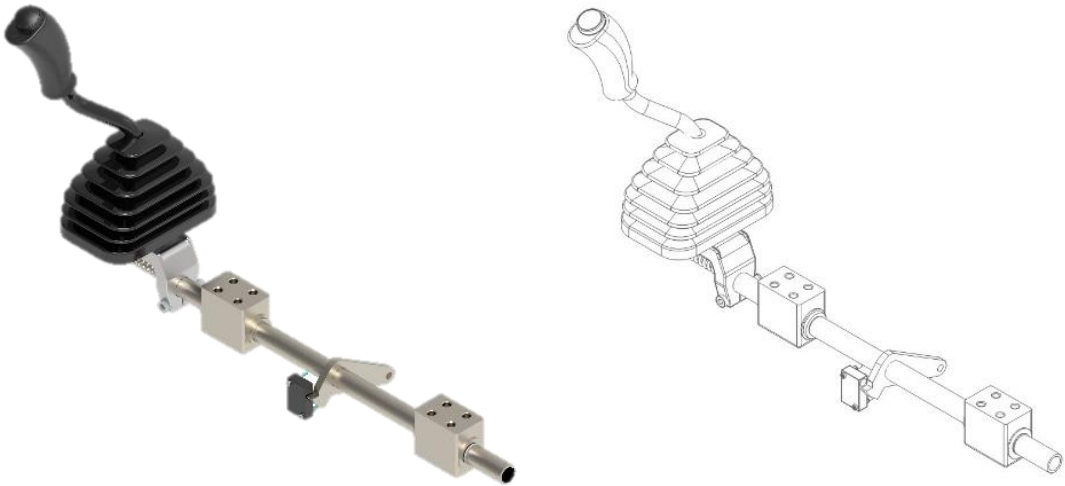

- FNR Lever
- Max. Travel: 56 mm.
- Bracket & Arm in Pressed Steel.
- Equipped With Neutral, Reverse & Vibration Cut Off Switch

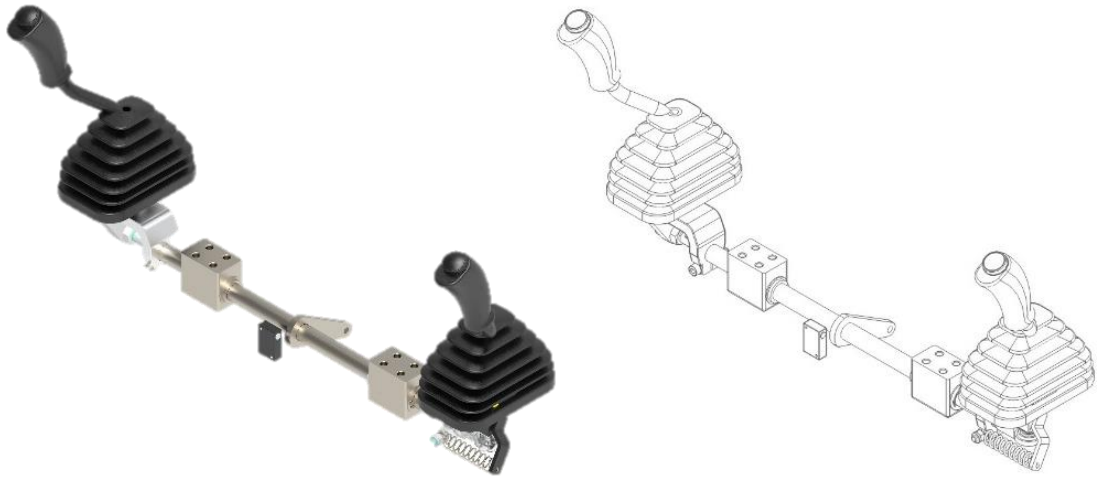

- ❑ FNR Lever
- ❑ Max. Travel: 56 mm.
- ❑ Bracket & Arm in Pressed Steel.
- ❑ Equipped With Neutral, Reverse & Vibration Cut Off Switch

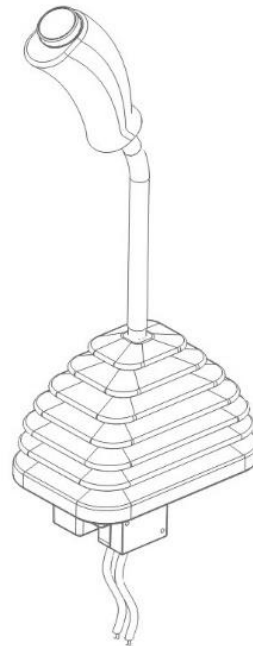

- Aluminium alloy Die cast construction.
- Max. travel : 60mm.
- Max. load : 50Kgf.
- Suitable for hydraulic motor control.



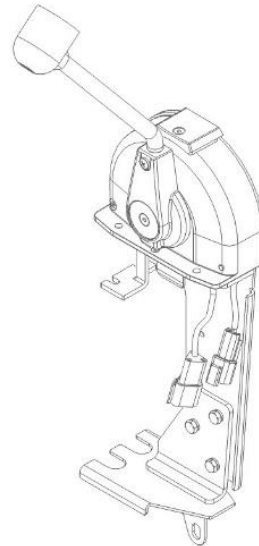

- FNR Lever For Traction Control.
- Housing : Aluminium Alloy.
- Travel : 70mm Max.
- Equipped with Neutral & Horn Switch.